



CDN S SERIES COUPLING / DECOUPLING NETWORK (CDN) FOR SCREENED OR COAXIAL CABLES







CDN ST08A

- Coupling networks designed for IEC / EN 61000-4-6
- S series for screened or coaxial cables
- CDN ST08A for twisted pairs with RJ45 socket
- Versions for USB, HDMI, RS232 and other specific applications

IEC / EN 61000-4-6 specifies the design and performance of a range of coupling/decoupling networks (CDNs). Each CDN is specific to the type of cable and the intended signal carried on the cable. Teseq offers an extensive range of CDNs which fully comply with the requirements of the standard and provide a simple and reliable method of injecting RF energy into the equipment under test (EUT).





Product range 10 kHz to 80 MHz

CDN type	Product name	Line type	Application	Connector EUT port	Connector AE port
S1	CDN S501-10	coaxial line	50 Ω coaxial line	BNC 50 Ω	BNC 50 Ω
USB	CDN USB/c-10	USB, screened	USB for central devices, USB up to 2.0	USB "B" type 	USB "A" type 
USB	CDN USB/p-10	USB, screened	USB for peripheral devices, USB up to 2.0	USB "A" type 	USB "B" type 
S8	CDN ST08-10	Telecommunication line, screened, up to 8 balanced lines (4 pairs)	up to 8 lines, e.g. Ethernet	RJ45	RJ45
S9	CDN S900-10	9 wires, screened	Data line up to 9 wires, RS232	D-Sub 9 pins	D-Sub 9 pins
S25	CDN S250-10	25 wires, screened	Data line up to 25 wires	D-Sub 25 pins	D-Sub 25 pins





CDN S SERIES

COUPLING / DECOUPLING NETWORK (CDN) FOR SCREENED OR COAXIAL CABLES

Product range 10 kHz to 230 MHz

CDN type	Product name	Line type	Application	Connector EUT port	Connector AE port
USB	CDN USB3/C-10	USB, screened, 9 lines, 10 kHz to 230 MHz	USB up to 3.0	USB "C" type 	USB "C" type 
USB	CDN USB3.0-10	USB, screened, 9 lines, 10 kHz to 230 MHz	USB up to 3.0	USB "A" type 	USB "A" type 





Product range 150 kHz to 230 MHz

CDN type	Product name	Line type	Application	Connector EUT port	Connector AE port
S1	CDN S501A	coaxial line	50 Ω coaxial line	BNC 50 Ω	BNC 50 Ω
S1	CDN S502A	coaxial line, double screened	50 Ω coaxial line	N 50 Ω	N 50 Ω
S1	CDN S751A	coaxial line	75 Ω coaxial line	BNC 75 Ω	BNC 75 Ω
S1	CDN S752A	coaxial line, double screened	75 Ω coaxial line	N 75 Ω	N 75 Ω
S2	CDN S200A	2 wires, screened	XLR-Audio, pin 1 to ground	XLR, 3 pins	XLR, 3 pins
S4	CDN S400	4 wires, screened	DIN-Audio, 5 pins, pin 2 to ground	DIN, 5 pins	DIN, 5 pins
USB	CDN USB/c	USB, screened	USB for central devices, USB up to 2.0	USB "B" type 	USB "A" type 
USB	CDN USB/p	USB, screened	USB for peripheral devices, USB up to 2.0	USB "A" type 	USB "B" type 
S8	CDN ST08A	Telecommunication line, screened, up to 8 balanced lines (4 pairs)	up to 8 lines, e.g. Ethernet	RJ45	RJ45

CDN S SERIES

COUPLING / DECOUPLING NETWORK (CDN) FOR SCREENED OR COAXIAL CABLES

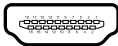
Product range 150 kHz to 230 MHz

CDN type	Product name	Line type	Application	Connector EUT port	Connector AE port
USB	CDN USB3.0	USB, screened, 9 lines	USB up to 3.0	USB "A" type 	USB "A" type 
S9	CDN S900	9 wires, screened	Data line up to 9 wires, RS232	D-Sub 9 pins	D-Sub 9 pins
S10	CDN ST10	Telecommunication line, screened, up to 10 balanced lines (4 pairs + 2 lines for +24 V and ground)	up to 8 lines, e.g. Ethernet	RJ45 (10 pins)	RJ45 (10 pins)
S15	CDN S150	15 wires, screened	Data line up to 15 wires	D-Sub 15 pins	D-Sub 15 pins
HDMI	CDN HDMI	HDMI, screened, 19 lines	High speed HDMI with HDCP, HEC (Ethernet), ARC and DSC		
S25	CDN S250	25 wires, screened	Data line up to 25 wires	D-Sub 25 pins	D-Sub 25 pins

CDN S SERIES

COUPLING / DECOUPLING NETWORK (CDN) FOR SCREENED OR COAXIAL CABLES

Electrical specification CDN S501-10

Frequency range:	10 kHz to 80 MHz
Power rating (EUT- and AE port)	
AC max. voltage (line to ground):	250 V
DC max. voltage (line to ground):	400 V
Current max.:	1000 mA
Test voltage:	750 V DC, 2 sec
Common mode impedance (EUT port)	
10 kHz to 24 MHz:	150 Ω \pm 20 Ω
24 MHz to 80 MHz:	150 Ω +60 Ω / -45 Ω
Coupling path (In/Out port/EUT)	
Connection:	BNC 50 Ω
RF voltage:	<20 V
Voltage division factor (RF input to EUT port)	
10 kHz to 80 MHz:	10 dB \pm 1 dB
3 dB Transmission bandwidth (wanted signal) EUT/AE:	> 2 GHz sin.
Decoupling of CM disturbance (RF port/AE)	
10 kHz to 80 MHz:	>60 dB

Electrical specification CDN USB/c-10 and CDN USB/p-10

Frequency range:	10 kHz to 80 MHz
Power rating (EUT- and AE port)	
AC max. voltage (line to ground):	100 V
DC max. voltage (line to ground):	100 V
Current max.:	1 A
Test voltage:	200 V DC, 2 sec
Common mode impedance (EUT port)	
10 kHz to 24 MHz:	150 Ω \pm 20 Ω
24 MHz to 80 MHz:	150 Ω +60 Ω / -45 Ω
Coupling path (In/Out port/EUT)	
Connection:	BNC 50 Ω
RF voltage:	<20 V
Voltage division factor (RF input to EUT port)	
10 kHz to 80 MHz:	10 dB \pm 1 dB
3 dB Transmission bandwidth (wanted signal) EUT/AE:	> 100 MHz sin. (data pair balanced)
Decoupling of CM disturbance (RF port/AE)	
10 kHz to 80 MHz:	>60 dB

CDN S SERIES

COUPLING / DECOUPLING NETWORK (CDN) FOR SCREENED OR COAXIAL CABLES

Electrical specification CDN ST08-10

Frequency range:	10 kHz to 80 MHz
Line parameters:	4 pairs, balanced, shielded, 100 Ω
Power rating (EUT- and AE port)	
AC max. voltage (line to ground):	100 V
DC max. voltage (line to ground):	150 V
Current max.:	1.2 A (per single line)
Test voltage:	200 V DC, 2 sec
Common mode impedance (EUT port)	
10 kHz to 24 MHz:	150 Ω \pm 20 Ω
24 MHz to 80 MHz:	150 Ω +60 Ω / -45 Ω
Coupling path (In/Out port/EUT)	
Connection:	BNC 50 Ω
RF voltage:	<20 V
Voltage division factor (RF input to EUT port)	
10 kHz to 80 MHz:	10 dB \pm 1 dB
3 dB Transmission bandwidth (wanted signal) EUT/AE:	> 250 MHz sin.
Decoupling of CM disturbance (RF port/AE)	
10 kHz to 80 MHz:	>60 dB

Electrical specification CDN S250-10 and S900-10

Frequency range:	10 kHz to 80 MHz
Power rating (EUT- and AE port)	
AC max. voltage (line to ground):	150 V
DC max. voltage (line to ground):	150 V
Current max.:	250 mA
Test voltage:	500 V DC, 2 sec
Common mode impedance (EUT port)	
10 kHz to 24 MHz:	150 Ω \pm 20 Ω
24 MHz to 80 MHz:	150 Ω +60 Ω / -45 Ω
Coupling path (In/Out port/EUT)	
Connection:	BNC 50 Ω
RF voltage:	<20 V
Voltage division factor (RF input to EUT port)	
10 kHz to 80 MHz:	10 dB \pm 1 dB
3 dB Transmission bandwidth (wanted signal) EUT/AE:	> 20 kHz sin.
Decoupling of CM disturbance (RF port/AE)	
10 kHz to 80 MHz:	>60 dB

CDN S SERIES

COUPLING / DECOUPLING NETWORK (CDN) FOR SCREENED OR COAXIAL CABLES

Electrical specification CDN USB3.0-10 and USB3/C-10

Frequency range:	10 kHz to 230 MHz
Power rating (EUT- and AE port)	
AC max. voltage (line to ground):	100 V
DC max. voltage (line to ground):	100 V
Current max.:	1 A
Test voltage:	500 V DC, 2 sec
Common mode impedance (EUT port)	
10 kHz to 24 MHz:	150 Ω \pm 20 Ω
24 MHz to 80 MHz:	150 Ω +60 Ω / -45 Ω
80 MHz to 230 MHz:	150 Ω \pm 60 Ω
Coupling path (In/Out port/EUT)	
Connection:	BNC 50 Ω
RF voltage:	<20 V
Voltage division factor (RF input to EUT port)	
10 kHz to 80 MHz:	10 dB \pm 1 dB
30 MHz to 230 MHz:	10 dB +3 dB / -2 dB
Decoupling of CM disturbance (RF port/AE)	
10 kHz to 80 MHz:	>60 dB
80 MHz to 230 MHz:	>40 dB

CDN S SERIES

COUPLING / DECOUPLING NETWORK (CDN) FOR SCREENED OR COAXIAL CABLES

Electrical specification CDN S501A, S502A, S751A and S752A

Frequency range:	150 kHz to 230 MHz
Power rating (EUT- and AE port)	
AC max. voltage (line to ground):	250 V
DC max. voltage (line to ground):	400 V
Current max.:	1000 mA
Test voltage:	750 V DC, 2 sec
Common mode impedance (EUT port)	
150 kHz to 24 MHz:	150 Ω \pm 20 Ω
24 MHz to 80 MHz:	150 Ω +60 Ω / -45 Ω
80 MHz to 230 MHz:	150 Ω \pm 60 Ω
Phase angle (EUT Port) 150 kHz to 30 MHz:	0° \pm 20°
Coupling path (In/Out port/EUT)	
Connection:	BNC 50 Ω
RF voltage:	< 20 V
Voltage division factor (RF input to EUT port)	
150 kHz to 80 MHz:	10 dB \pm 1 dB
80 MHz to 230 MHz:	10 dB +3 dB / -2 dB
3 dB Transmission bandwidth (wanted signal) EUT/AE:	> 2 GHz sin.
Decoupling of CM disturbance (RF port/AE)	
150 kHz:	>60 dB
1.5 MHz:	>60 dB
30 MHz:	>50 dB
230 MHz:	>40 dB

Cable specification CDN S502A

Screen:	double screen
Impedance:	50 Ω \pm 2
Min. screening effectiveness:	> 85 dB (up to 1 GHz)
Max. operating frequency:	6 GHz
Max. operating voltage:	2.5 kVrms (at sea level)
Test voltage:	5 kVrms (50 Hz / 1 min)

CDN S SERIES

COUPLING / DECOUPLING NETWORK (CDN) FOR SCREENED OR COAXIAL CABLES

Cable specification CDN S752A

Screen:	double screen
Impedance:	75 Ω \pm 1.5
Min. screening effectiveness:	> 78 dB (up to 3 GHz)
Max. operating frequency:	2 GHz
Max. operating voltage:	3 kVrms (at sea level)
Test voltage:	6 kVrms (50 Hz / 1 min)

Electrical specification CDN S150, S200A, S250, S400, S900 and S900m

Frequency range:	150 kHz to 230 MHz
Power rating (EUT- and AE port)	
AC max. voltage (line to ground):	150 V (CDN S400: 34 V)
DC max. voltage (line to ground):	150 V (CDN S400: 34 V)
Current max.:	250 mA
Test voltage:	500 V DC, 2 sec
Common mode impedance (EUT port)	
150 kHz to 24 MHz:	150 Ω \pm 20 Ω
24 MHz to 80 MHz:	150 Ω +60 Ω / -45 Ω
80 MHz to 230 MHz:	150 Ω \pm 60 Ω
Coupling path (In/Out port/EUT)	
Connection:	BNC 50 Ω
RF voltage:	< 20 V
Voltage division factor (RF input to EUT port)	
150 kHz to 80 MHz:	9.5 dB \pm 1 dB
80 MHz to 230 MHz:	9.5 dB +3 dB / -2 dB
3 dB Transmission bandwidth (wanted signal) EUT / AE:	> 20 kHz sin.
Decoupling of CM disturbance (RF port / AE)	
150 kHz:	>60 dB
1.5 MHz:	>60 dB
30 MHz:	>50 dB
230 MHz:	>40 dB

CDN S SERIES

COUPLING / DECOUPLING NETWORK (CDN) FOR SCREENED OR COAXIAL CABLES

Electrical specification CDN ST08A

Frequency range:	150 kHz to 230 MHz
Line parameters:	4 pairs, balanced, shielded, 100 Ω impedance
Power rating (EUT- and AE Port)	
AC max. voltage:	100 V
DC max. voltage:	150 V
Current max.:	1.2 A (per single line)
Test voltage:	200 VDC, 2 sec
Common mode impedance (EUT Port)	
150 kHz to 30 MHz:	150 Ω \pm 20 Ω
30 MHz to 80 MHz:	150 Ω +60 Ω / -45 Ω
80 MHz to 230 MHz:	150 Ω \pm 60 Ω
Phase angle (EUT Port) 150 kHz to 30 MHz:	0° \pm 20°
Coupling path (In/Out-port/EUT)	
Connection:	BNC 50 Ω
RF voltage:	< 20 V
Voltage division factor (RF input to EUT port)	
150 kHz to 30 MHz:	9.5 dB \pm 1 dB
30 MHz to 230 MHz:	9.5 dB +4 dB / -2 dB
3 dB Transmission bandwidth (wanted signal) EUT / AE: *	> 250 MHz sin.
Decoupling of common mode disturbances (EUT / AE)	
150 kHz to 1.5 MHz:	\geq 60 dB
1.5 MHz to 30 MHz:	\geq 60 dB
230 MHz:	>40 dB

*) all balanced parameters are in relation to a symmetrical load of 100 Ω

CDN S SERIES

COUPLING / DECOUPLING NETWORK (CDN) FOR SCREENED OR COAXIAL CABLES

Electrical specification CDN ST10

Frequency range:	150 kHz to 230 MHz
Line parameters:	4 pairs, balanced, shielded, 100 Ω impedance, 2 lines for +24 V and ground
Power rating (EUT- and AE Port)	
AC max. voltage:	100 V
DC max. voltage:	150 V
Current max.:	1.2 A (per single line)
Test voltage:	200 VDC, 2 sec
Common mode impedance (EUT Port)	
150 kHz to 30 MHz:	150 Ω \pm 20 Ω
30 MHz to 80 MHz:	150 Ω +60 Ω / -45 Ω
80 MHz to 230 MHz:	150 Ω \pm 60 Ω
Phase angle (EUT Port) 150 kHz to 30 MHz:	0° \pm 20°
Coupling path (In/Out-port/EUT)	
Connection:	BNC 50 Ω
RF voltage:	< 20 V
Voltage division factor (RF input to EUT port)	
150 kHz to 30 MHz:	10 dB \pm 1 dB
30 MHz to 230 MHz:	10 dB +4 dB / -2 dB
3 dB Transmission bandwidth (wanted signal) EUT/AE: *	> 100 MHz sin.
Decoupling of common mode disturbances (EUT/AE)	
150 kHz to 1.5 MHz:	\geq 60 dB
1.5 MHz to 30 MHz:	\geq 60 dB
230 MHz:	>40 dB

*) all balanced parameters are in relation to a symmetrical load of 100 Ω

CDN S SERIES

COUPLING / DECOUPLING NETWORK (CDN) FOR SCREENED OR COAXIAL CABLES

Electrical specification CDN USB/c and USB/p

Frequency range:	150 kHz to 230 MHz
Power rating (EUT- and AE port)	
AC max. voltage (line to ground):	100 V
DC max. voltage (line to ground):	100 V
Current max.:	1 A
Test voltage:	200 V DC, 2 sec
Common mode impedance (EUT port)	
150 kHz to 24 MHz:	150 Ω \pm 20 Ω
24 MHz to 80 MHz:	150 Ω +60 Ω / -45 Ω
80 MHz to 230 MHz:	150 Ω \pm 60 Ω
Coupling path (In/Out port/EUT)	
Connection:	BNC 50 Ω
RF voltage:	< 20 V
Voltage division factor (RF input to EUT port)	
150 kHz to 80 MHz:	9.5 dB \pm 1 dB
80 MHz to 230 MHz:	9.5 dB +3 dB / -2 dB
3 dB Transmission bandwidth (wanted signal) EUT/AE:	> 80 MHz sin. (data pair balanced)
Decoupling of CM disturbance (RF port/AE)	
150 kHz:	>60 dB
1.5 MHz:	>60 dB
30 MHz:	>50 dB
230 MHz:	>40 dB

CDN S SERIES

COUPLING / DECOUPLING NETWORK (CDN) FOR SCREENED OR COAXIAL CABLES

Electrical specification CDN USB3.0

Frequency range:	150 kHz to 230 MHz
Line parameters:	according USB 3.0 specification, screened 9 lines
Power rating (EUT- and AE Port)	
AC max. voltage:	100 V
DC max. voltage:	100 V
Current max.:	1 A
Common mode impedance (EUT Port)	
150 kHz to 30 MHz:	150 Ω \pm 20 Ω
30 MHz to 80 MHz:	150 Ω +60 Ω / -45 Ω
80 MHz to 230 MHz:	150 Ω \pm 60 Ω
Coupling path (In/Out-port/EUT)	
Connection:	BNC 50 Ω
RF voltage:	<20 V
Voltage division factor (RF input to EUT port)	
150 kHz to 30 MHz:	10 dB \pm 1 dB
30 MHz to 230 MHz:	10 dB +3 dB / -2 dB
Decoupling of common mode disturbances (EUT / AE)	
150 kHz:	>60 dB
1.5 MHz:	>60 dB
30 MHz:	>50 dB
230 MHz:	>40 dB

CDN S SERIES

COUPLING / DECOUPLING NETWORK (CDN) FOR SCREENED OR COAXIAL CABLES

Electrical specification CDN HDMI

Frequency range:	150 kHz to 230 MHz
Line parameters:	according HDMI specification, screened 19 lines
Power rating (EUT- and AE Port)	
AC max. voltage:	100 V
DC max. voltage:	150 V
Current max.:	according HDMI specification
Common mode impedance (EUT Port)	
150 kHz to 30 MHz:	150 Ω \pm 20 Ω
30 MHz to 80 MHz:	150 Ω +60 Ω / -45 Ω
80 MHz to 230 MHz:	150 Ω \pm 60 Ω
Coupling path (In/Out-port/EUT)	
Connection:	BNC 50 Ω
RF voltage:	<20 V
Voltage division factor (RF input to EUT port)	
150 kHz to 30 MHz:	10 dB \pm 1 dB
30 MHz to 230 MHz:	10 dB +3 dB / -2 dB
Decoupling of common mode disturbances (EUT / AE)	
150 kHz:	>60 dB
1.5 MHz:	>60 dB
30 MHz:	>50 dB
230 MHz:	>40 dB

Mechanical specifications

Size (W x H x L):	100 mm x 100 mm x 240 mm (CDN HDMI, CDN S752A and CDN ST10: 288 mm)
Weight:	approx. 1.5 kg

Environmental conditions

Classification:	Indoor use only
Operating temperature:	+5°C to +40°C
Relative humidity:	up to 80%

CDN S SERIES COUPLING / DECOUPLING NETWORK (CDN) FOR SCREENED OR COAXIAL CABLES

Example of test set-up calibration

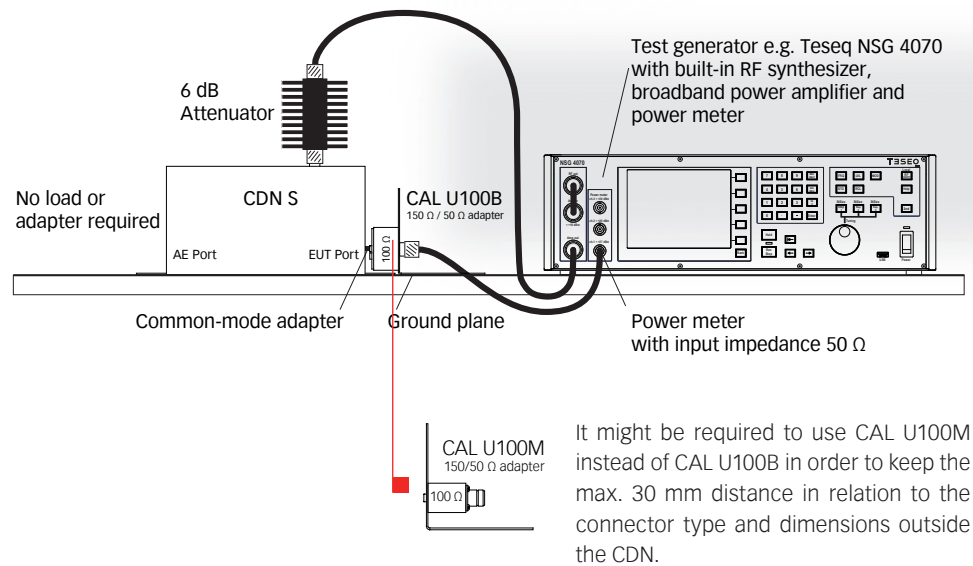

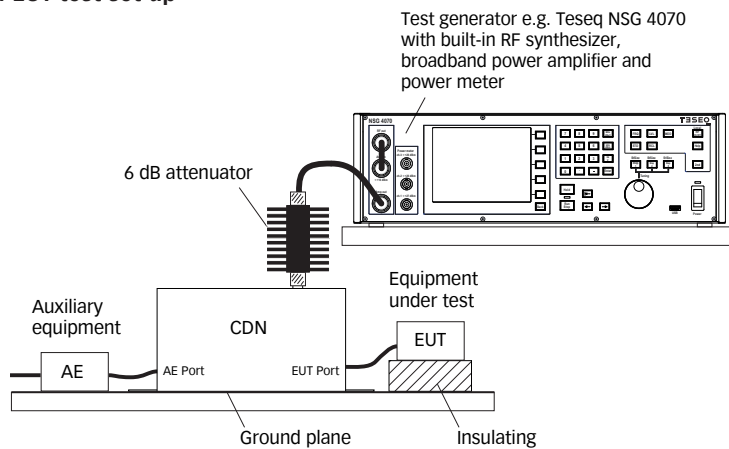

Example of EUT test set-up

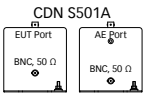
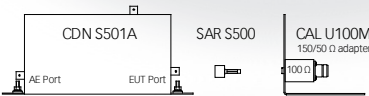
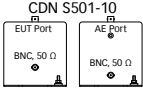
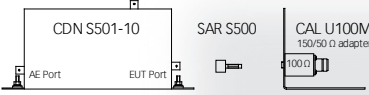
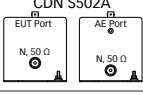
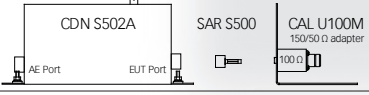
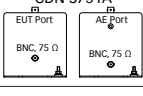
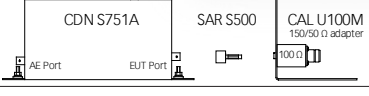
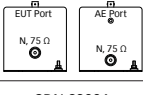
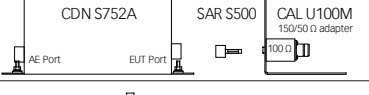
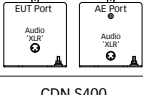
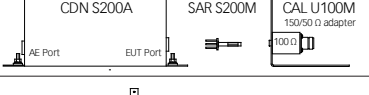
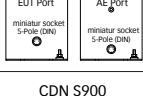
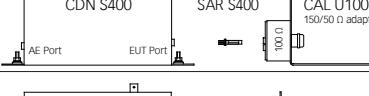
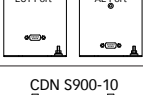
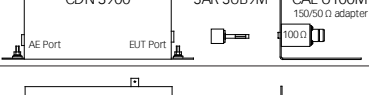
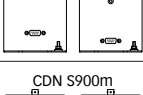
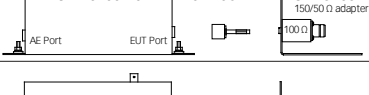
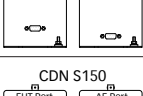
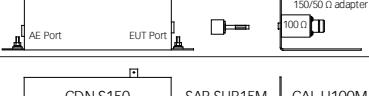
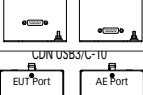
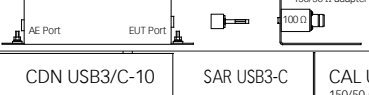

CDN S SERIES

COUPLING / DECOUPLING NETWORK (CDN) FOR SCREENED OR COAXIAL CABLES

Product	Drawing	Adapters for test level setting (parts of the set option)
CDN S501A		
CDN S501-10		
CDN S502A		
CDN S751A		
CDN S752A		
CDN S200A		
CDN S400		
CDN S900		
CDN S900-10		
CDN S900m		
CDN S150		
CDN USB3/C-10		

CDN S SERIES

COUPLING / DECOUPLING NETWORK (CDN) FOR SCREENED OR COAXIAL CABLES

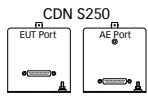
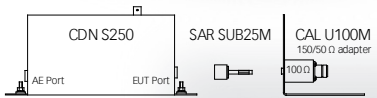
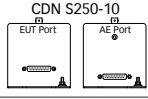
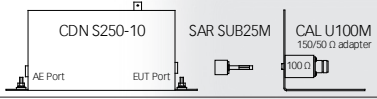
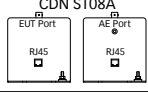
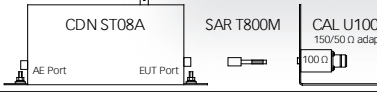
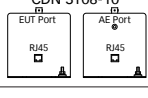
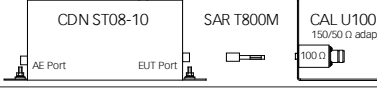
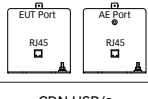
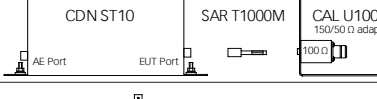
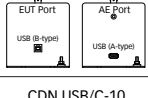
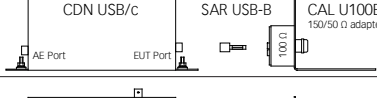
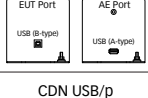
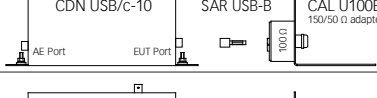
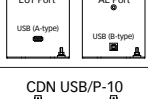
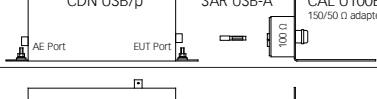
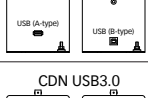
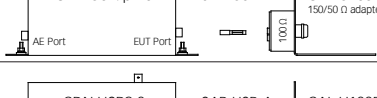
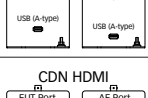
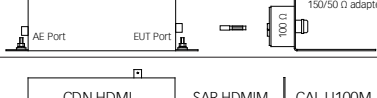
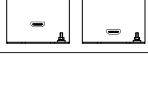
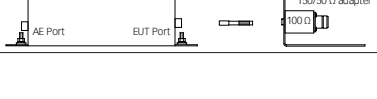
Product	Drawing	Adapters for test level setting (parts of the set option)
CDN S250		
CDN S250-10		
CDN ST08A		
CDN ST08-10		
CDN ST10		
CDN USB/c		
CDN USB/c-10		
CDN USB/p		
CDN USB/p-10		
CDN USB3.0		
CDN HDMI		

CDN S SERIES

COUPLING / DECOUPLING NETWORK (CDN) FOR SCREENED OR COAXIAL CABLES

Model No. and options

Product	Description	Order code
CDN S150	Coupling Decoupling Network for IEC 61000-4-6, type S15, 230 MHz (D-Sub)	231008
CDN S150S	Coupling Decoupling Network for IEC 61000-4-6, type S15, 230 MHz (D-Sub) with calibration adapter in storage case, includes CAL U100M, SAR SUB15M	244147
CDN S200A	Coupling Decoupling Network for IEC 61000-4-6, type S2, 230 MHz (audio), XLR pin 1 to ground	257808
CDN S200AS	Coupling Decoupling Network for IEC 61000-4-6, type S2, 230 MHz (audio), XLR pin 1 to ground, with calibration adapter in storage case, includes CAL U100M, SAR S200M	257809
CDN S250	Coupling Decoupling Network for IEC 61000-4-6, type S25, 230 MHz (D-Sub)	231009
CDN S250S	Coupling Decoupling Network for IEC 61000-4-6, type S25, 230 MHz (D-Sub) with calibration adapter in storage case, includes CAL U100M, SAR SUB25M	244148
CDN S250-10	Coupling Decoupling Network for IEC 61000-4-6, type S25, 10 kHz to 80 MHz (D-Sub)	242480
CDN S250-10S	Coupling Decoupling Network for IEC 61000-4-6, type S25, 10 kHz to 80 MHz (D-Sub) with calibration adapter in storage case, includes CAL U100M, SAR SUB25M	242488
CDN S400	Coupling Decoupling Network for IEC 61000-4-6, type S4, 230 MHz (DIN)	231006
CDN S400S	Coupling Decoupling Network for IEC 61000-4-6, type S4, 230 MHz (DIN) with calibration adapter in storage case, includes CAL U100B, SAR S400	244145
CDN S501A	Coupling Decoupling Network for IEC 61000-4-6, type S1, 230 MHz (BNC 50 Ω)	248664
CDN S501AS	Coupling Decoupling Network for IEC 61000-4-6, type S1, 230 MHz (BNC 50 Ω) with calibration adapter in storage case, includes CAL U100M, SAR S500	248656
CDN S501-10	Coupling Decoupling Network for IEC 61000-4-6, type S1 (BNC 50 Ω), 10 kHz to 80 MHz	242471
CDN S501-10S	Coupling Decoupling Network for IEC 61000-4-6, type S1 (BNC 50 Ω), 10 kHz to 80 MHz with calibration adapter set in storage case, includes CAL U100M, SAR S500	242472
CDN S502A	Coupling Decoupling Network for IEC 61000-4-6, type S1, 230 MHz (N 50 Ω), double screened	248662
CDN S502AS	Coupling Decoupling Network for IEC 61000-4-6, type S1, 230 MHz (N 50 Ω), double screened with calibration adapter in storage case, includes CAL U100M, SAR S500	248657
CDN S751A	Coupling Decoupling Network for IEC 61000-4-6, type S1, 230 MHz (BNC 75 Ω)	248668
CDN S751AS	Coupling Decoupling Network for IEC 61000-4-6, type S1, 230 MHz (BNC 75 Ω) with calibration adapter in storage case, includes CAL U100M, SAR S500	248658
CDN S752A	Coupling Decoupling Network for IEC 61000-4-6, type S1, 230 MHz (N 75 Ω), double screened	248666
CDN S752AS	Coupling Decoupling Network for IEC 61000-4-6, type S1, 230 MHz (N 75 Ω), double screened with calibration adapter in storage case, includes CAL U100M, SAR S500	248659
CDN S900	Coupling Decoupling Network for IEC 61000-4-6, type S9, 230 MHz (D-Sub)	231007
CDN S900S	Coupling Decoupling Network for IEC 61000-4-6, type S9, 230 MHz (D-Sub) with calibration adapter in storage case, includes CAL U100M, SAR SUB9M	244146
CDN S900m	Coupling Decoupling Network for IEC 61000-4-6, type S9, 230 MHz (D-Sub, male)	256766
CDN S900mS	Coupling Decoupling Network for IEC 61000-4-6, type S9, 230 MHz (D-Sub, male) with calibration adapter in storage case, includes CAL U100M, SAR SUB9fm	256767
CDN S900-10	Coupling Decoupling Network for IEC 61000-4-6, type S9 10 kHz to 80 MHz (D-Sub)	242478

CDN S SERIES

COUPLING / DECOUPLING NETWORK (CDN) FOR SCREENED OR COAXIAL CABLES

Model No. and options (continued)

Product	Description	Order code
CDN S900-10S	Coupling Decoupling Network for IEC 61000-4-6, type S9 10 kHz to 80 MHz (D-Sub) with calibration adapter set in storage case, includes CAL U100M, SAR SUB9M	242485
CDN ST08A	Coupling Decoupling Network for IEC 61000-4-6, type for screened eight lines with RJ45 connector	242109
CDN ST08AS	Coupling Decoupling Network for IEC 61000-4-6, type for screened eight lines with RJ45 connector with calibration adapter in storage case, includes CAL U100M, SAR T800M	242116
CDN ST08-10	Coupling Decoupling Network for IEC 61000-4-6, type for screened eight lines with RJ45 connector, 10 kHz to 80 MHz	242479
CDN ST08-10S	Coupling Decoupling Network for IEC 61000-4-6, type for screened eight lines with RJ45 connector, 10 kHz to 80 MHz with calibration adapter set in storage case, includes CAL U100M, SAR T800M	242486
CDN ST10	Coupling Decoupling Network for IEC 61000-4-6, type for screened 10 lines with RJ45 connector	257983
CDN ST10S	Coupling Decoupling Network for IEC 61000-4-6, type for screened 10 lines with RJ45 connector with calibration adapter in storage case, includes CAL U100M, SAR T1000M	257959
CDN USB3/C-10	Coupling Decoupling Network for IEC 61000-4-6, type S16 with USB connector type "C", 10 kHz to 230 MHz.	261102
CDN USB3/C-10S	Coupling Decoupling Network for IEC 61000-4-6, type S16 with USB connector type "C", 10 kHz to 230 MHz, calibration adapter in storage case, includes CAL U100B, SAR USB3-C	261103
CDN USB 3.0-10	Coupling Decoupling Network for IEC 61000-4-6, type S9 with USB connector type "A", 10 kHz to 230 MHz.	261110
CDN USB 3.0-10S	Coupling Decoupling Network for IEC 61000-4-6, type S9 with USB connector type "A", 10 kHz to 230 MHz, calibration adapter in storage case, includes CAL U100B, SAR USB-A	261109
CDN USB3.0	Coupling Decoupling Network for IEC 61000-4-6, type S9 with USB connector type "A"	242546
CDN USB3.0S	Coupling Decoupling Network for IEC 61000-4-6, type S9 with USB connector type "A" and calibration adapter in storage case, includes CAL U100B, SAR USB-A	242559
CDN USB/c	Coupling Decoupling Network for IEC 61000-4-6, type with USB connector (EUT-central device)	237501
CDN USB/cS	Coupling Decoupling Network for IEC 61000-4-6, type with USB connector (EUT-central device) with calibration adapter in storage case, includes CAL U100B, SAR USB-B	244150
CDN USB/c-10	Coupling Decoupling Network for IEC 61000-4-6, type with USB connector (EUT-central device), 10 kHz to 80 MHz	247777
CDN USB/c-10S	Coupling Decoupling Network for IEC 61000-4-6, type with USB connector (EUT-central device), 10 kHz to 80 MHz, with calibration adapter in storage case, includes CAL U100B, SAR USB-B	247778
CDN USB/p	Coupling Decoupling Network for IEC 61000-4-6, type with USB connector (EUT-peripheral devices)	237503
CDN USB/pS	Coupling Decoupling Network for IEC 61000-4-6, type with USB connector (EUT-peripheral devices) with calibration adapter in storage case, includes CAL U100B, SAR USB-A	244151
CDN USB/p-10	Coupling Decoupling Network for IEC 61000-4-6, type with USB connector (EUT-peripheral devices), 10 kHz to 80 MHz	247779
CDN USB/p-10S	Coupling Decoupling Network for IEC 61000-4-6, type with USB connector (EUT-peripheral devices), 10 kHz to 80 MHz, with calibration adapter in storage case, includes CAL U100B, SAR USB-A	247780
CDN HDMI	Coupling Decoupling Network for IEC 61000-4-6, type S19 for HDMI	242545
CDN HDMIS	Coupling Decoupling Network for IEC 61000-4-6, type S19 for HDMI and calibration adapter in storage case, includes CAL U100M, SAR HDMIM	242558
CDN-TC	Traceable calibration (ISO17025) for IEC 61000-4-6 requirements, order only with device CDN M, AF or S type	97-231024

CDN S SERIES

COUPLING / DECOUPLING NETWORK (CDN) FOR SCREENED OR COAXIAL CABLES

Model No. and options (continued)

Product	Description	Order code
CDN-DAkKS	DAkKS accredited calibration (ISO17025) for impedance and VDF in the frequency range of the CDN	98-231024
CAL U100B	Universal calibration unit (150 Ω / 50 Ω adapter)	247825
CAL U100M	Universal calibration unit (150 Ω / 50 Ω adapter)	257138
CAL U100X-TC	Traceable calibration (ISO17025), order only with CAL U100x device	97-247825
CAL U100X-DAkKS	DAkKS accredited calibration (ISO17025), order only with CAL U100x device	98-247825
IMA U100	Universal impedance measuring adapter (0 Ω)	239902
IMA U100M	Universal impedance measuring adapter (0 Ω)	257137
SAR M116	Adapter 4 mm banana	239915
SAR S400	Common mode adapter for DIN	247838
SAR S500	Calibration adapter part for BNC and N	242440
SAR USB-A	Common-mode adapter for USB connector type "A"	247835
SAR USB-B	Common-mode adapter for USB connector type "B"	247836
SAR S200M	Common mode adapter for XLR	257950
SAR SUB9M	Common mode adapter for D-Sub 9 pins (screened)	257951
SAR SUB9fm	Common mode adapter for D-Sub 9 pins (screened), female version, fits for CDN S900m	247845
SAR SUB15M	Common mode adapter for D-Sub 15 pins (screened)	257952
SAR SUB25M	Common mode adapter for D-Sub 25 pins (screened)	257953
SAR T800M	Common mode adapter for RJ45	257954
SAR T1000M	Common mode adapter for RJ45 with 10 pins	257958
SAR HDMIM	Common mode adapter for HDMI	257957
A 50-BNC	Termination 50 Ohms, BNC type, male	257520
A 50-N	Termination 50 Ohms, N type, male, 1 Watt, 2.5 GHz	257521
CDN case1	Storage case for CDN (size 1) for e.g. CDN M316 and similar	257100
CDN case3	Storage case for CDN (size 3) for CDN HDMI, CDN S752A, CDN ST10	257102

AMETEK CTS Europe GmbH
Landsberger Str. 255 · 12623 Berlin · Germany
T +49 30 56 59 88 35 F +49 30 56 59 88 34
customer care.cts@ametek.com
www.ametek-cts.com

82-242471 E07 December 2021

© December 2021 Teseq®
Specifications subject to change without notice.
Teseq® is an ISO-registered company. Its products are designed and manufactured under the strict quality and environmental requirements of the ISO 9001. This document has been carefully checked. However, Teseq® does not assume any liability for errors or inaccuracies.